

### FEATURES

- 200mV Max Dropout at 10mA Output Current
- 4 $\mu$ A Typical Quiescent Current
- 0.15% Max Initial Accuracy (S8)
- No Output Capacitor Required
- Output Sources 10mA, Sinks 2mA
- 40ppm/ $^{\circ}$ C Max Drift (S8)
- Voltage Options: 2.5V, 3V, 4.1V, 5V and Adjustable
- Available in Small MSOP Package

### APPLICATIONS

- Battery-Powered Systems
- Handheld Instruments
- Precision Power Supplies
- A/D and D/A Converters

### DESCRIPTION

The LTC<sup>®</sup>1258/LTC1258-2.5/LTC1258-3/LTC1258-4.1/LTC1258-5 are micropower bandgap references that combine high accuracy and low drift with very low supply current and small package size. The combination of ultralow quiescent current and low dropout voltage of only 200mV maximum makes them ideal for battery-powered equipment. The output voltage is set by an external resistor divider for the adjustable LTC1258.

This series of references uses curvature compensation to obtain low temperature coefficient and trimmed thin-film resistors to achieve high output accuracy. These references can source up to 10mA and sink up to 2mA, making them ideal for precision regulator applications. They are stable without an output bypass capacitor, but are also stable with capacitance up to 1 $\mu$ F. This feature is important in critical applications where PC board space is a premium and fast settling is demanded.

The LTC1258 series references provide power dissipation advantages over shunt references. In addition to supply current, shunt references must also idle the entire load current to operate.

The LTC1258 series is available in the 8-pin MSOP and SO packages.

LT, LT, LTC and LTM are registered trademarks of Linear Technology Corporation. All other trademarks are the property of their respective owners.

### TYPICAL APPLICATION

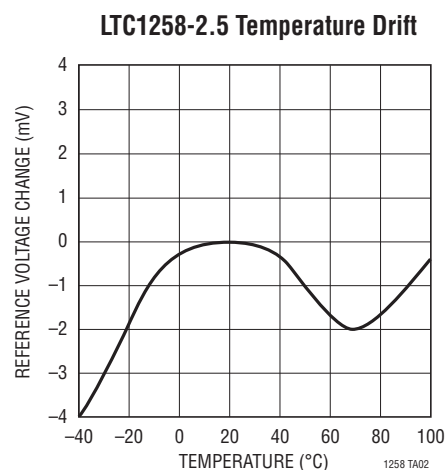
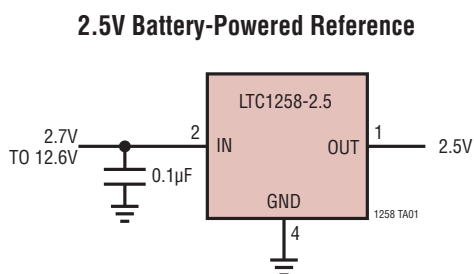

1258sfb

# LTC1258 Series

## ABSOLUTE MAXIMUM RATINGS (Note 1)

|                                     |              |  |                |
|-------------------------------------|--------------|--|----------------|
| Supply Voltage .....                | 13V          | Operating Temperature Range (Note 2)..     | -40°C to 100°C |
| Input Voltages .....                | -0.3V to 13V | Specified Temperature Range .....          | 0°C to 70°C    |
| Output Voltages .....               | -0.3V to 13V | Storage Temperature Range (Note 3).....    | -65°C to 150°C |
| Output Short-Circuit Duration ..... | Indefinite   | Lead Temperature (Soldering, 10 sec) ..... | 300°C          |

## PIN CONFIGURATION

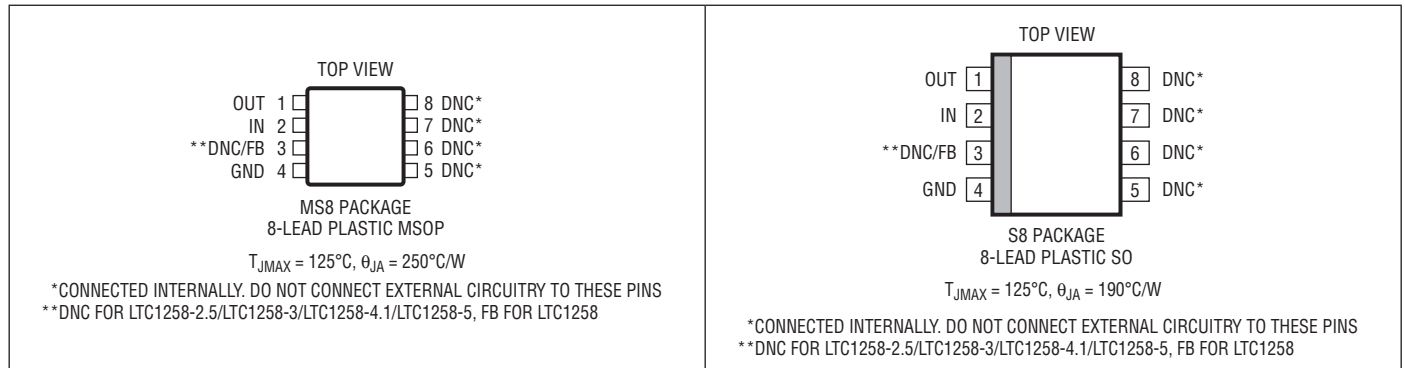

## ORDER INFORMATION

| LEAD FREE FINISH           | TAPE AND REEL         | PART MARKING | PACKAGE DESCRIPTION | TEMPERATURE RANGE |
|----------------------------|-----------------------|--------------|---------------------|-------------------|
| LTC1258CMS8#PBF (OBSOLETE) | LTC1258CMS8#TRPBF     | LTEL         | 8-Lead Plastic MSOP | 0°C to 70°C       |
| LTC1258CMS8-2.5#PBF        | LTC1258CMS8-2.5#TRPBF | LTCF         | 8-Lead Plastic MSOP | 0°C to 70°C       |
| LTC1258CMS8-3#PBF          | LTC1258CMS8-3#TRPBF   | LTEU         | 8-Lead Plastic MSOP | 0°C to 70°C       |
| LTC1258CMS8-4.1#PBF        | LTC1258CMS8-4.1#TRPBF | LTEN         | 8-Lead Plastic MSOP | 0°C to 70°C       |
| LTC1258CMS8-5#PBF          | LTC1258CMS8-5#TRPBF   | LTEM         | 8-Lead Plastic MSOP | 0°C to 70°C       |
| LTC1258CS8#PBF (OBSOLETE)  | LTC1258CS8#TRPBF      | 1258         | 8-Lead Plastic SO   | 0°C to 70°C       |
| LTC1258CS8-2.5#PBF         | LTC1258CS8-2.5#TRPBF  | 12582        | 8-Lead Plastic SO   | 0°C to 70°C       |
| LTC1258CS8-3#PBF           | LTC1258CS8-3#TRPBF    | 12583        | 8-Lead Plastic SO   | 0°C to 70°C       |
| LTC1258CS8-4.1#PBF         | LTC1258CS8-4.1#TRPBF  | 125841       | 8-Lead Plastic SO   | 0°C to 70°C       |
| LTC1258CS8-5#PBF           | LTC1258CS8-5#TRPBF    | 12585        | 8-Lead Plastic SO   | 0°C to 70°C       |

Consult LTC Marketing for parts specified with wider operating temperature ranges.

Consult LTC Marketing for information on non-standard lead based finish parts.

For more information on lead free part marking, go to: <http://www.linear.com/leadfree/>

For more information on tape and reel specifications, go to: <http://www.linear.com/tapeandreeel/>

## AVAILABLE OPTIONS

| OUTPUT VOLTAGE (V) | TEMPERATURE RANGE (°C) | ACCURACY (%) | TEMPERATURE COEFFICIENT (ppm/°C) | PACKAGE TYPE   |              |                 |              |
|--------------------|------------------------|--------------|----------------------------------|----------------|--------------|-----------------|--------------|
|                    |                        |              |                                  | SO-8 (S8)      |              | MSOP-8 (MS8)    |              |
|                    |                        |              |                                  | ORDER NUMBER   | PART MARKING | ORDER NUMBER    | PART MARKING |
| 2.5                | 0 to 70                | 0.15         | 40                               | LTC1258CS8-2.5 | 12582        | LTC1258CMS8-2.5 | LTCF         |
| 2.5                | 0 to 70                | 0.21         | 60                               |                |              |                 |              |
| 3                  | 0 to 70                | 0.15         | 40                               | LTC1258CS8-3   | 12583        | LTC1258CMS8-3   | LTEU         |
| 3                  | 0 to 70                | 0.20         | 60                               |                |              |                 |              |
| 4.096              | 0 to 70                | 0.15         | 40                               | LTC1258CS8-4.1 | 125841       | LTC1258CMS8-4.1 | LTEN         |
| 4.096              | 0 to 70                | 0.18         | 60                               |                |              |                 |              |
| 5                  | 0 to 70                | 0.15         | 40                               | LTC1258CS8-5   | 12585        | LTC1258CMS8-5   | LTEM         |
| 5                  | 0 to 70                | 0.18         | 60                               |                |              |                 |              |
| <b>OBSOLETE</b>    |                        |              |                                  |                |              |                 |              |
| Adjustable         | 0 to 70                | 0.4          | 40                               | LTC1258CS8     | 1258         | LTC1258CMS8     | LTEL         |
| Adjustable         | 0 to 70                | 0.46         | 60                               |                |              |                 |              |

**ELECTRICAL CHARACTERISTICS** The ● denotes the specifications which apply over the full operating temperature range, otherwise specifications are at  $T_A = 25^\circ\text{C}$ .  $V_{IN} = V_{OUT(NOMINAL)} + 0.2\text{V}$ ,  $I_{OUT} = 0\text{mA}$ ,  $FB = \text{OUT}$  for the LTC1258 unless otherwise noted.

| SYMBOL            | PARAMETER                                | CONDITIONS  | MIN  | TYP  | MAX  | UNITS  |
|-------------------|--|---|--|--|--|--|
| $V_{IN}$          | Input Voltage Range                      |   |  |  | 12.6   | V  |
| $I_{IN}$          | Input Current                            | $FB = \text{OUT}$ for LTC1258   |  | 4  | 6.5<br>8.5   | $\mu\text{A}$<br>$\mu\text{A}$                 |
| $V_{OUT}$         | Output Voltage (Note 4)                  | LTC1258 (S8), $FB = \text{OUT}$<br>LTC1258-2.5 (S8)<br>LTC1258-3 (S8)<br>LTC1258-4.1 (S8)<br>LTC1258-5 (S8)<br>LTC1258 (MS8), $FB = \text{OUT}$<br>LTC1258-2.5 (MS8)<br>LTC1258-3 (MS8)<br>LTC1258-4.1 (MS8)<br>LTC1258-5 (MS8) | 2.3755<br>2.4963<br>2.9955<br>4.090<br>4.9925<br>2.374<br>2.4948<br>2.994<br>4.0885<br>4.991 | 2.385<br>2.5<br>3<br>4.096<br>5<br>2.385<br>2.5<br>3<br>4.096<br>5 | 2.3945<br>2.5037<br>3.0045<br>4.102<br>5.0075<br>2.396<br>2.5052<br>3.006<br>4.1035<br>5.009 | V<br>V<br>V<br>V<br>V<br>V<br>V<br>V<br>V<br>V |
| $e_n$             | Output Voltage Noise (Note 5)            | $0.1\text{Hz} \leq f \leq 10\text{Hz}$  |  | 8  |  | ppm <sub>P-P</sub>                             |
| TC                | Output Voltage Temp Coefficient (Note 6) | $T_{MIN} \leq T_J \leq T_{MAX}$ (S8)<br>$T_{MIN} \leq T_J \leq T_{MAX}$ (MS8)   |  | 15   | 40<br>60   | ppm/°C<br>ppm/°C                               |
| $V_{OUT}/V_{IN}$  | Line Regulation                          | $V_{IN} = (V_{OUT(NOMINAL)} + 0.2\text{V})$ to 12.6V  |  | 30   | 120  | ppm/V  |
| $V_{OUT}/I_{OUT}$ | Load Regulation (Note 7)                 | Sourcing 0mA to 10mA<br>Sinking 0mA to 2mA  |  | 0.1  | 0.3<br>1.75<br>4.0<br>6.5  | mV/mA<br>mV/mA<br>mV/mA                        |
| $I_{SC}$          | Short-Circuit Output Current             | $V_{OUT}$ Shorted to GND<br>$V_{OUT}$ Shorted to $V_{IN}$   | 20<br>2  | 40<br>4  |  | mA<br>mA                                       |
| $\Delta V_{DO}$   | Dropout Voltage (Note 8)                 | $I_{OUT} = 0$ , $\Delta V_{OUT} \leq 0.1\%$<br>$I_{OUT} = 10\text{mA}$ , $\Delta V_{OUT} \leq 0.1\%$  |  |  | 100<br>200   | mV<br>mV                                       |
| $V_{HYST}$        | Output Hysteresis (Note 9)               | $\Delta T = -40^\circ\text{C}$ to $85^\circ\text{C}$<br>$\Delta T = 0^\circ\text{C}$ to $70^\circ\text{C}$  |  | 200<br>50  |  | ppm<br>ppm                                     |
| $I_{FB}$          | FB Pin Input Current                     | LTC1258, $OUT = FB$   |  | 10   |  | nA   |

**Note 1:** Stresses beyond those listed under Absolute Maximum Ratings may cause permanent damage to the device. Exposure to any Absolute Maximum Rating condition for extended periods may affect device reliability and lifetime.

**Note 2:** The LTC1258 is guaranteed functional over the operating temperature range of  $-40^\circ\text{C}$  to  $100^\circ\text{C}$ .

**Note 3:** If the part is stored outside of the specified operating temperature range, the output may shift due to hysteresis.

# LTC1258 Series

## ELECTRICAL CHARACTERISTICS

**Note 4:** ESD (electrostatic discharge) sensitive device. Extensive use of ESD protection devices are used internal to the LTC1258, however, high electrostatic discharge can damage or degrade the device. Use proper ESD handling precautions.

**Note 5:** Peak-to-peak noise is measured with a single pole highpass filter at 0.1Hz and 2-pole lowpass filter at 10Hz.

**Note 6:** Temperature coefficient is the change in output voltage divided by the nominal output voltage divided by the specified temperature range.

**Note 7:** Load regulation is measured on a pulse basis from no load to the specified load current. Output changes due to die temperature change must be taken into account separately.

**Note 8:** Dropout voltage is  $(V_{IN} - V_{OUT})$  when  $V_{OUT}$  falls to 0.1% below its nominal value at  $V_{IN} = V_{OUT} + 0.5V$ .

**Note 9:** Hysteresis in output voltage is created by package stress that differs depending on whether the IC was previously at a higher or lower temperature. Output voltage is always measured at 25°C, but the IC is cycled hot or cold before successive measurements. Hysteresis is not normally a problem for operational temperature excursions where the instrument might be stored at high or low temperature.

## TYPICAL PERFORMANCE CHARACTERISTICS

**LTC1258-2.5\* Dropout Voltage vs Output Source Current**

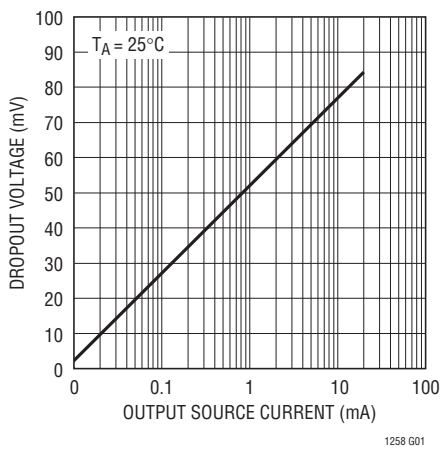

**LTC1258-2.5\* Input Current vs Temperature**

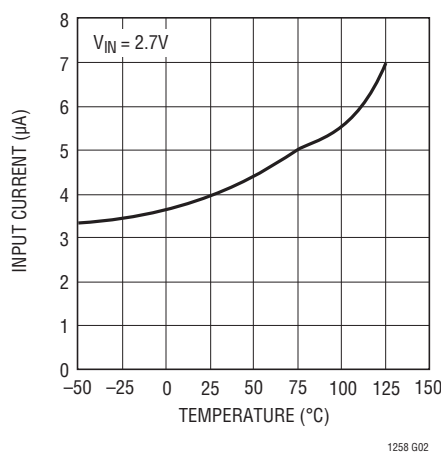

**LTC1258 Series Output Short-Circuit Current vs Temperature**

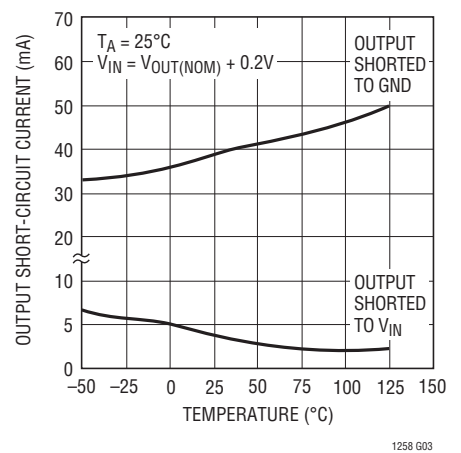

**LTC1258-2.5\* Output Short-Circuit vs Input Voltage**

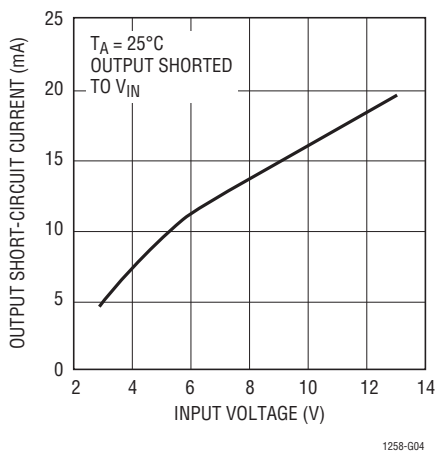

**LTC1258-2.5\* Output Short-Circuit Current vs Input Voltage**

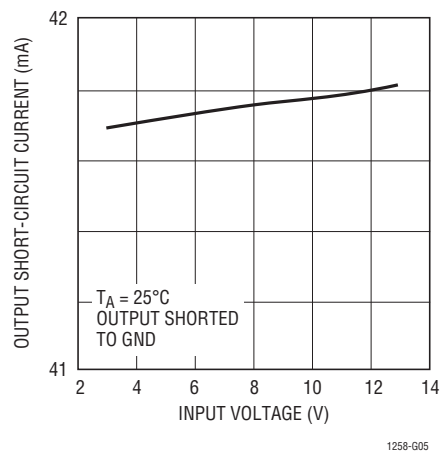

**LTC1258 Series Load Regulation**

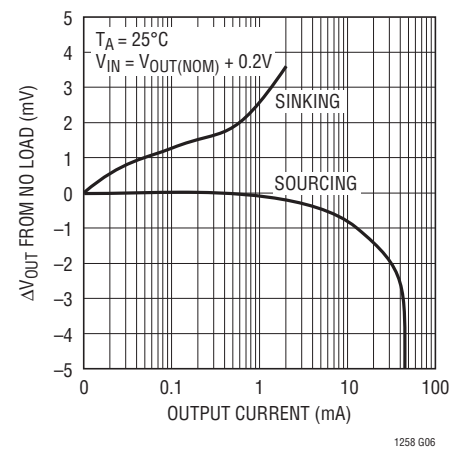

\*Similar performance characteristics can be expected for all voltage options.

## TYPICAL PERFORMANCE CHARACTERISTICS

**LTC1258-2.5 Output Voltage vs Input Voltage**

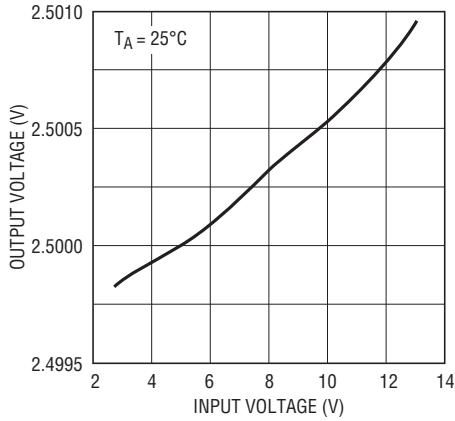

1258 G07

**LTC1258-2.5 Input Current vs Input Voltage**

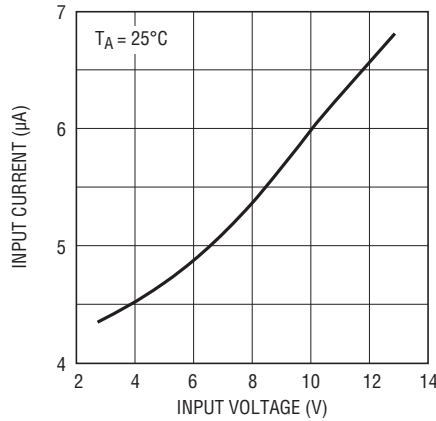

1258 G08

**LTC1258-2.5 PSRR vs Frequency**

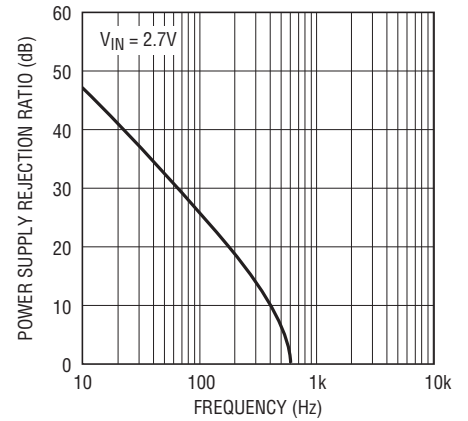

1258 G09

**LTC1258-2.5 0.1Hz to 10Hz Noise**

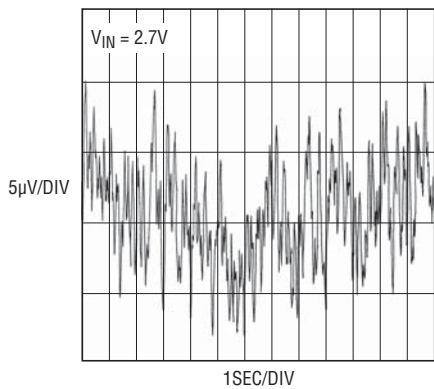

1258 G10

**LTC1258-5 Input Current vs Input Voltage in Dropout**

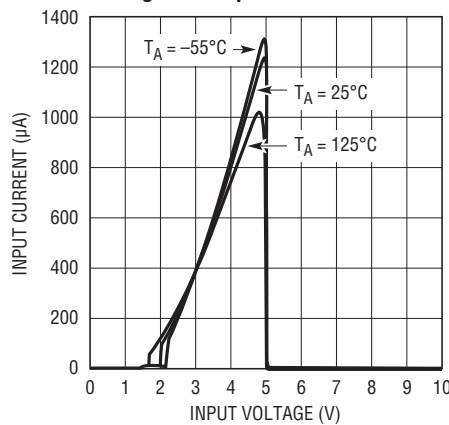

1258 G11

**LTC1258-2.5 Input Current vs Input Voltage in Dropout**

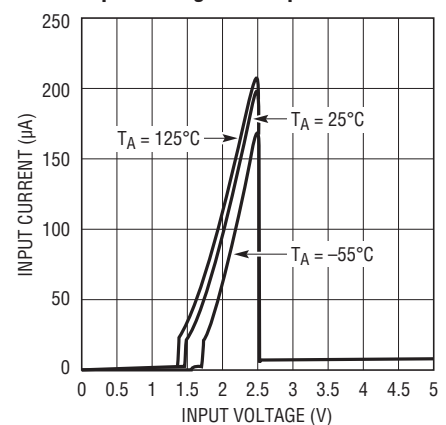

1258 G12

## PIN FUNCTIONS

**OUT (Pin 1):** Reference Output. The output can source up to 10mA and sink up to 2mA. It is stable with output bypass capacitor ranging from 0µF to 1µF.

**IN (Pin 2):** Positive Supply. Bypassing with a 0.1µF capacitor is recommended if the output loading changes.  $(V_{OUT} + 0.2V) \leq V_{IN} \leq 12.6V$ .

**DNC (Pin 3):** (LTC1258-2.5/LTC1258-3/LTC1258-4.1/LTC1258-5) Do Not Connect. Connected internally for post package trim. This pin must be left unconnected.

**FB (Pin 3):** (LT1258) Resistor Divider Feedback Pin. Connect a resistor divider from OUT to GND and the center tap to FB. This pin sets the output potential.

$$V_{OUT} = 2.385V \left( \frac{R1+R2}{R2} \right); R1 \text{ is connected from OUT to FB and } R2 \text{ from FB to GND.}$$

**GND (Pin 4):** Negative Supply or Ground Connection.

**DNC (Pins 5, 6, 7, 8):** Do Not Connect. Connected internally for post package trim. These pins must be left unconnected.

1258sfb

## BLOCK DIAGRAM

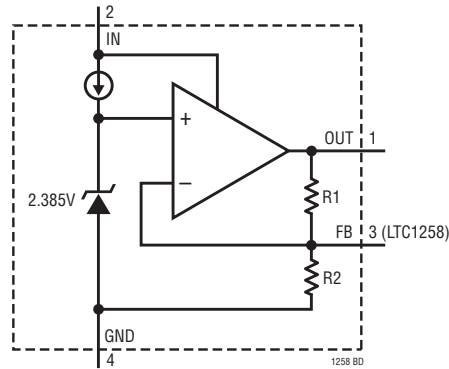

NOTE: R1 AND R2 ARE NOT CONNECTED FOR LTC1258

## APPLICATIONS INFORMATION

### Longer Battery Life

Series references have an advantage over shunt style references. To operate, shunt references require a resistor between the power supply and the output. This resistor must be chosen to supply the maximum current that is demanded by the circuit being regulated. When the circuit being controlled is not operating at this maximum current, the shunt reference must always sink this current, resulting in high power dissipation and short battery life.

The LTC1258 series low dropout references do not require a current setting resistor and can operate with any supply voltage from  $(V_{OUT(NOMINAL)} + 0.2V)$  to 12.6V. When the circuitry being regulated does not demand current, the LTC1258 series reduces its dissipation and battery life is extended. If the reference is not delivering load current it dissipates only  $10.8\mu W$  when operating on a 2.7V supply for LTC1258-2.5, yet the same connection can deliver 10mA of load current when demanded.

### Output Bypass Capacitor

The LTC1258 series is designed to be stable with or without capacitive loads. With no capacitive load, the reference is ideal for fast settling applications, or where PC board space is at a premium.

In applications with significant output loading changes, an output bypass capacitor of up to  $1\mu F$  can be used to improve the output transient response. Figure 1 shows the response of the reference to a 1mA to 0mA load step with a  $1\mu F$  output capacitor. If more than  $1\mu F$  of output capacitance is required, a resistor in series with the capacitor is recommended to reduce the output ringing. Figure 2 illustrates the use of a damping resistor for capacitive loads greater than  $1\mu F$ . Figure 3 shows the resistor and capacitor values required to achieve critical damping.

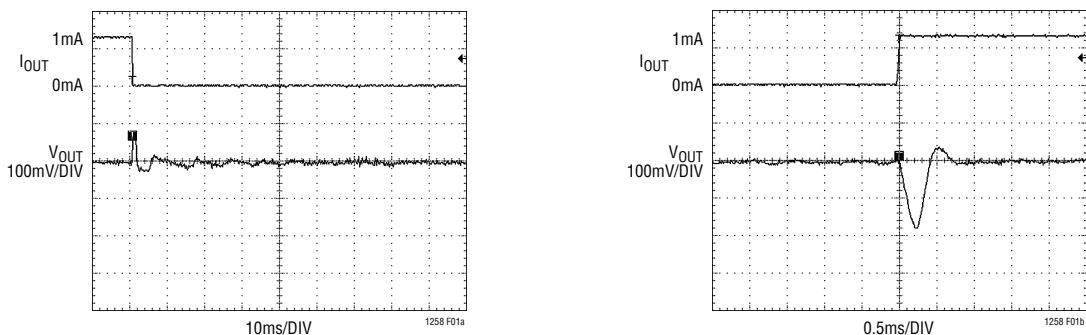
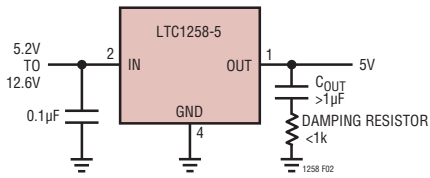

Figure 1. Reference Output Load Transient Response,  $1\mu F$  Output Capacitor

1258sfb

## APPLICATIONS INFORMATION



**Figure 2. Adding a Damping Resistor with Output Capacitors Greater Than 1µF**

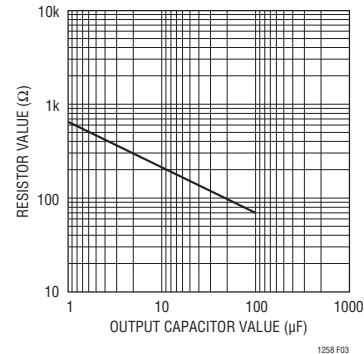

**Figure 3. Damping Resistance vs Output Capacitor Value**

### Internal P-Channel Pass Transistor

The LTC1258 series features an internal P-channel MOSFET pass transistor. This provides several advantages over similar designs using a PNP bipolar pass transistor.

These references consume only 4µA of quiescent current under light and heavy loads as well as in dropout; whereas,

PNP-based references waste considerable amounts of current when the pass transistor is saturated. In addition, the LTC1258 series provides a lower dropout voltage (200mV max) than PNP-based references.

## PACKAGE DESCRIPTION

### MS8 Package 8-Lead Plastic MSOP

(Reference LTC DWG # 05-08-1660 Rev F)

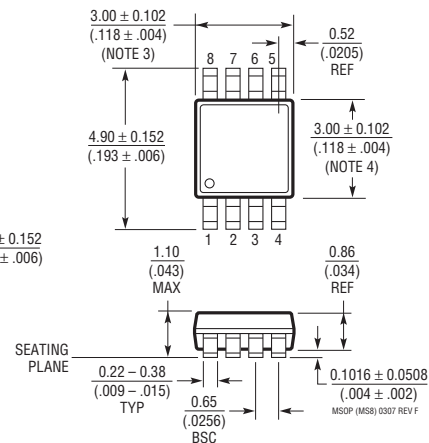
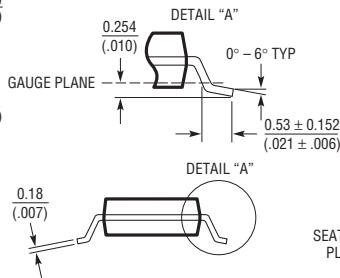
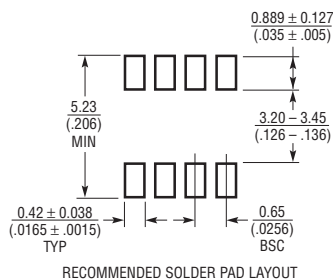

- NOTE:  
 1. DIMENSIONS IN MILLIMETER/(INCH)  
 2. DRAWING NOT TO SCALE  
 3. DIMENSION DOES NOT INCLUDE MOLD FLASH, PROTRUSIONS OR GATE BURRS.  
 MOLD FLASH, PROTRUSIONS OR GATE BURRS SHALL NOT EXCEED 0.152mm (.006") PER SIDE

4. DIMENSION DOES NOT INCLUDE INTERLEAD FLASH OR PROTRUSIONS.  
 INTERLEAD FLASH OR PROTRUSIONS SHALL NOT EXCEED 0.152mm (.006") PER SIDE  
 5. LEAD COPLANARITY (BOTTOM OF LEADS AFTER FORMING) SHALL BE 0.102mm (.004") MAX

### S8 Package 8-Lead Plastic Small Outline (Narrow .150 Inch)

(Reference LTC DWG # 05-08-1610)

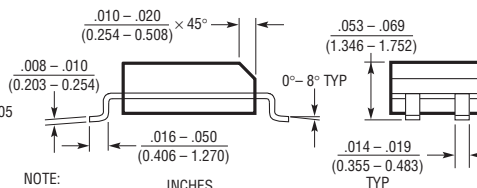
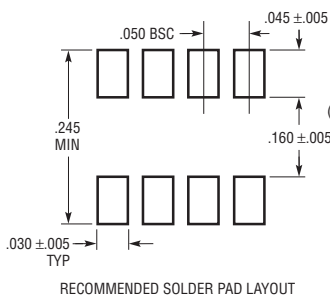

- NOTE:  
 1. DIMENSIONS IN INCHES (MILLIMETERS)  
 2. DRAWING NOT TO SCALE  
 3. THESE DIMENSIONS DO NOT INCLUDE MOLD FLASH OR PROTRUSIONS.  
 MOLD FLASH OR PROTRUSIONS SHALL NOT EXCEED .006" (0.15mm)

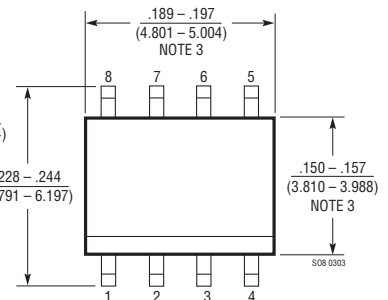

1258sfb

# LTC1258 Series

## TYPICAL APPLICATIONS

**Micropower Low Dropout Negative Reference**

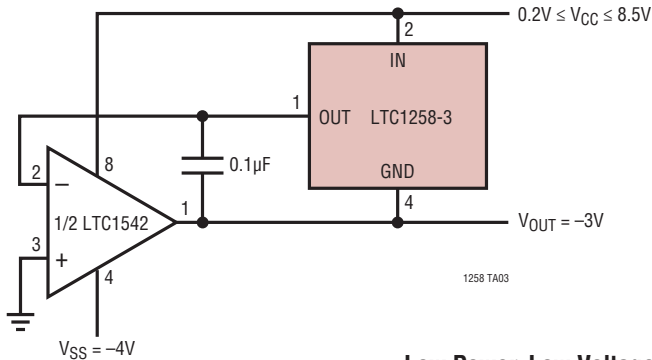

**Supply Splitter**

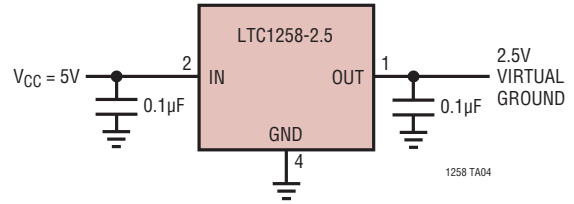

**Low Power, Low Voltage Supply Reference for LTC1069L**

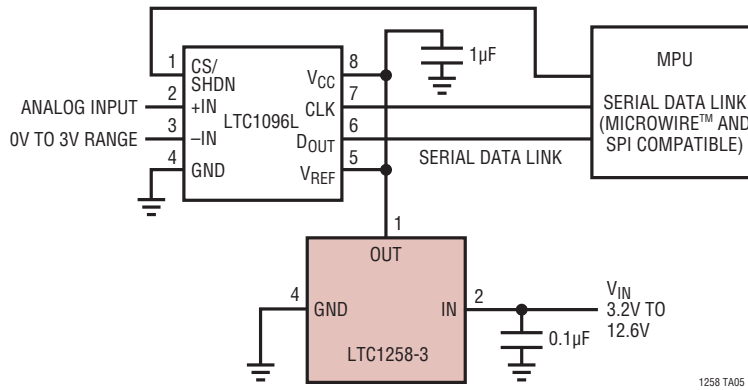

## RELATED PARTS

| PART NUMBER          | DESCRIPTION                                  | COMMENTS  |
|----------------------|--|---|
| LT <sup>®</sup> 1389 | Nanopower Precision Shunt Voltage Reference  | 800nA Quiescent Current, 0.05% Max, 10ppm/°C Max Drift, 1.25V and 2.5V Versions, SO-8 Package |
| LT1634               | Micropower Precision Shunt Voltage Reference | 0.05% Max, 25ppm/°C Max Drift, 1.25V, 2.5V, 4.096V and 5V Outputs                             |
| LT1460               | Micropower Series Reference                  | 0.075% Max, 10ppm/°C Max Drift, 2.5V, 5V and 10V Outputs                                      |
| LT1461               | LDO Micropower Precision Reference           | 0.04% Max, 3ppm/°C Max Drift in SO-8  |
| LT1790               | SOT-23, LDO Micropower Precision Reference   | 0.05% Max, 10ppm/°C Max   |